

# INSTALLATION INSTRUCTIONS

## Remodel Housing

DO NOT INSTALL IN INSULATION - SUITABLE FOR DAMP LOCATION

LEU-RELDLD1, LEU-RELDLD2, LEU-RELDLE1, LEU-RELDLE2

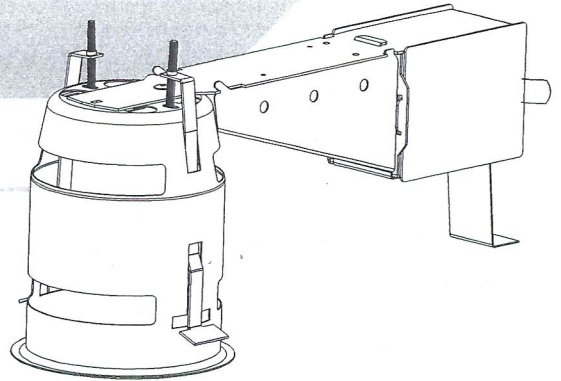

A 7" minimum clearance inside the ceiling is required to ensure proper installation of this housing.

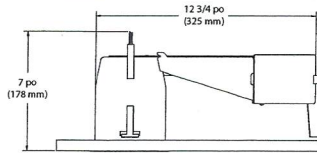

1. **SHUT OFF ELECTRICAL SUPPLY AT SOURCE.**
2. Bring the electrical wiring to the housing as per applicable local electrical codes
3. Cut the hole to a diameter of:  $\varnothing$  3-5/8" (92 mm)
4. Remove the junction box cover by pushing on the spring latch (1).

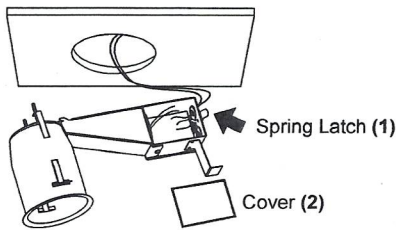

6. Insert fixture (2) in the ceiling opening.

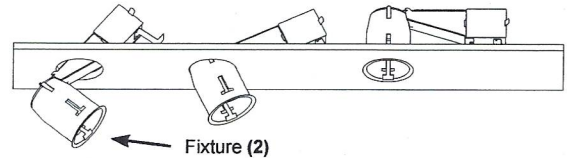

7. Push the fastening hooks (3) through the lateral openings and fasten the fixture with the adjustment screws (4).

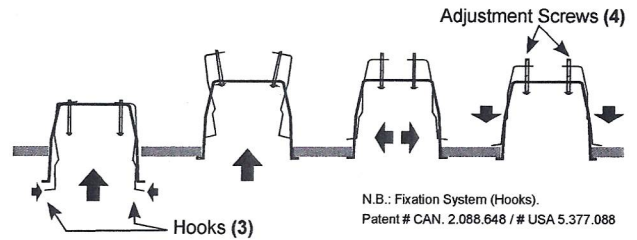

5. Connect the wires based on diagrams below. Close the junction box.

### Diagram ELV dimmer (E1 - E2)

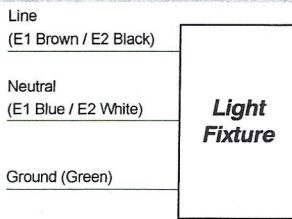

### Diagram 0-10V dimmer (D1 - D2)

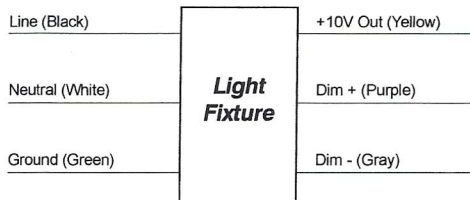

8. Install the trim.

Connect the male and female connectors.

Push connected wires in the pot then push the trim in the can.

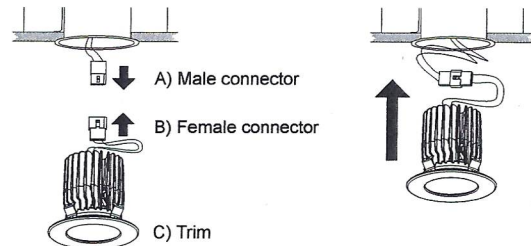

Please keep these installation instructions for future maintenance.



**CAUTION** The use of another company's products or components in conjunction with this product may not be covered by UL approvals, and could be hazardous. Such use automatically voids all warranties and responsibility for any problems that may result from such use.



### WARNING SHOCK AND FIRE HAZARD

Most dwellings built before 1985 have supply wires rated 60°C. Consult a qualified electrician before installing.

Please visit the Website to see the list of compatible dimmers or for more details.

# LEUCOS

11 Mayfield Avenue Edison, NJ 08837  
t 732.225.0010 f 732.225.0250  
www.leucosusa.com

© 2015 Leucos USA  
All rights reserved  
EL636 (Rev. A) 103712  
2015-04